



Engine

MakeKubota
 Model1105
 Cylinders3
 Fuel typeDiesel
 Cylinder volume cm³1123
 Cooling systemFluid

Power

SAE, gross power kW/hp19,4/26,4
 Max gross torque Nm72
 At engine speed r/min2200
 Max engine speed without load r/min3000

Electrical system

Battery V-Ah12-53
 Generator A40

Service volumes

Cooling system l6
 Engine oil l5
 Fuel tank l20
 Hydraulic tank l50
 Hydraulic system total volume l55

Performance

Lifting power hydraulic kg1250
 Breakout force 50 cm kg960
 Tipping load, straight kg1150
 Tipping load, articulated kg770
 Operating weight kg1320
 Drive speed low km/h0-9
 Drive speed high km/h0-19
 Pulling force high kg1100
 Pulling force low kg550

Hydraulic system

Working hydraulics l/min(18+24) 42
 System pressure bar240
 Drivetrain hydraulics l/min63
 Drivetrain max system pressure bar350

Cycle times

Raising boom s3,7
 Lowering boom s2,2
 Folding in bucket s2,6
 Tipping bucket s1,6
 Steering wheel rotations L/R rev3/4

Tires

Dimension23x10,5-12TR

Versatile hydraulics

Norcar a6226 has the same compact design as the a6026, but with higher specifications as standard. Equipped with dual working hydraulic pumps, the machine is well prepared for attachments requiring high oil flow. Moreover, several functions can be used simultaneously without affecting each other, which makes work more efficient.

The machine offers high pulling force, speed and lifting power as standard, and is a machine for professional use.

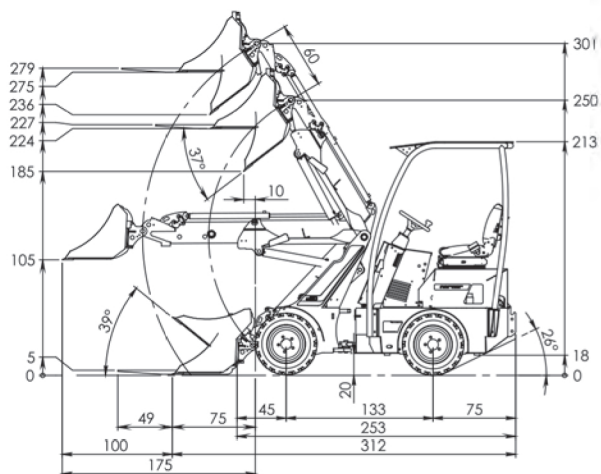
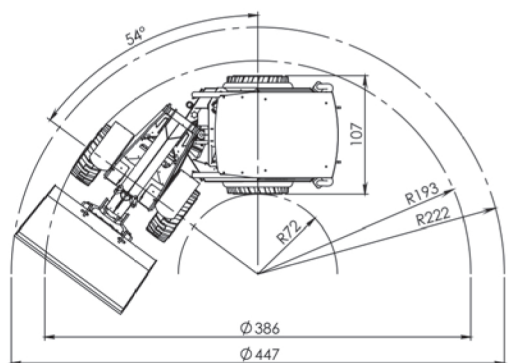

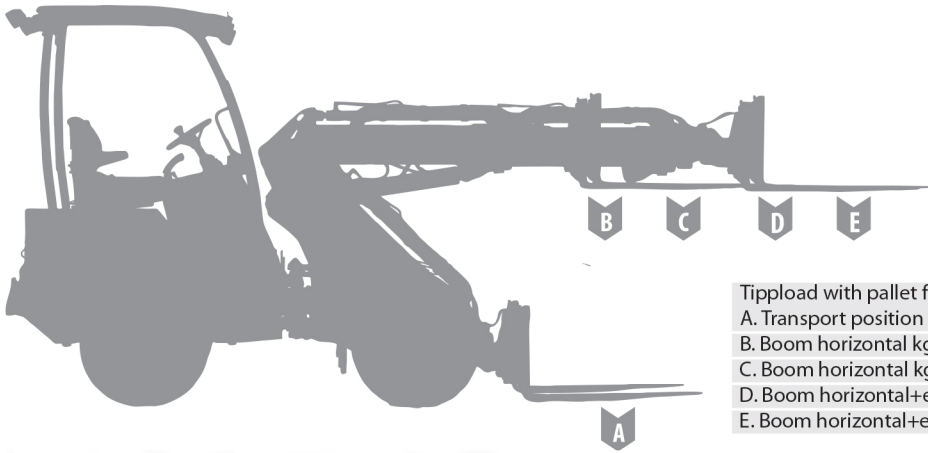

	Standard machine		+extra weight 180 kg	
Tippload with pallet fork	Straight	Articulated	Straight	Articulated
A. Transport position kg	940	640	940	780
B. Boom horizontal kg	1180	790	1200	980
C. Boom horizontal kg	850	510	1100	660
D. Boom horizontal+extension 710	440	440	800	570
E. Boom horizontal+extension 550	340	340	730	425

Standard equipment a6226

Roll bar ROPS/FOPS, seatbelt
 Working lights, front
 Electrically maneuvered parking brake/safety system
 Float on the lifting boom
 Hand throttle/Foot throttle
 Engine speed and hour meter, engine heat and fuel level gauges
 Suspension seat with armrests
 Adjustable steering column
 ProDrive



MultiFaster Quick release coupling

The MultiFaster Quick release makes changes of hydraulic tools easy and quick. All the hydraulic connections are completed with a simple hand motion and makes it impossible to cross connect. Pressure is automatically released and no oil will leak.



Telescope Extension Boom

600mm telescope boom gives good lifting height and reach. Electronically controlled using lifting boom's joystick.



Parallel leveller

Keeps equipment in the set position regardless of the boom's movements. Increases safety and precision during lifts, especially with pallet forks.



Hydraulic Outlet, rear, single

Single acting hydraulic outlet (R2) and free return (R3). Controls hydraulic attachments directly with joystick buttons. Rear hydraulic outlets should not be connected at the same time as hydraulic outlet, front. Hydraulic oil flow max 42 l/min.



Hydraulic Oil Cooler

Maintains hydraulic oil's temperature at correct level while operating tools that require high oil flow during long driving periods.



High Capacity Hydraulics

Dual working hydraulic pumps provide selectable flow (18/42 l/min) for hydraulic outlets. Telescope extension boom and external hydraulics work independently of each other, regardless of the boom's movements.



Two Speed Ranges

Change between pulling force and speed. Low gear: 0-9km/h, pulling force 1100kg High gear: 0-19km/h, pulling force 550kg.



Tire 23 x 10,5-12 TR

Tractor patterned tire. Provides good traction and is suitable for softer surfaces such as soil, sand, and gravel. Tread pattern is designed to keep the tire clean while driving on wet surfaces. Machine width 113 cm.



Traction control

Provides better traction on slippery or uneven surfaces. Traction is guaranteed on the same side wheels.



FOPS Protective Roof

Steel roof that protects the operator from falling objects.

Extra equipment a6226



**Stage 3B
Tier 4**

Environmental engine
Diesel engine with emission class Tier 4. Environmentally friendly engine with low emissions. The engine is built to meet the emission requirements for Tier 4 in the United States.

7004952



Full traction control
Provides continuous traction on all wheels, regardless of terrain.

7004522



Oscillation lock
Locks the loader's pendular movement in the joint. Can be used during eg.leveling tasks when the tool needs to be parallel to the rear wheels.

7004532



Automotive
Automotive drive system allows the operator to change direction using a control switch on the loaders joystick. The loader is easy to operate and especially suitable for loading, janitorial jobs and when there's a need for driving longer distances.

7007411



Tire 23 x 10,5-12 GR
Densely patterned tire. Soft tire that is gentle to surfaces and grips well. Suitable for work on grass, gravel paths and roads. The tire is also good on snow and ice. Tire width gives low ground pressure. Machine width 113 cm.

7004513



Tire 23 x 10 -12 IN
Compact puncture proof tire without air. Durable and can withstand heavy loads. Increases machine weight. Machine width 113 cm.

7004514



Tire 23x8,5-12 GR
Densely patterned tire. Soft tire that is gentle to surfaces and grips well. Suitable for work on grass, gravel paths and roads. The tire is also good on snow and ice. Tire width gives low ground pressure. Machine width 99 cm.

7007037



Tire 23 x 12,5 -12 GR
Densely patterned tire. Soft tire that is gentle to surfaces and grips well. Suitable for work on grass, gravel paths and roads. The tire is also good on snow and ice. Tire width gives low ground pressure. Machine width 125 cm.

7004512



Tire 23 x 8,5-12 IN
Durable multi-purpose tire that can withstand heavy loads. Suitable for work on harder surfaces such as asphalt, concrete, and hard packed gravel. Machine width 99 cm.

7004510



Tire 23 x 8,5-12 IN
Durable multi-purpose tire that can withstand heavy loads. Suitable for work on harder surfaces such as asphalt, concrete, and hard packed gravel. Machine width 107 cm.

7004511



Extra Hydraulic Outlet, front
Electrically operated double-acting hydraulic outlets (4 and 5). Provides the ability to control several hydraulic functions on attachments directly with buttons on the joystick. Hydraulic oil flow max 18 l/min.

7004509



Hydraulic Outlet, rear, double
Double acting hydraulic outlet (R1 and R2) and free return (R3). Controls hydraulic attachments directly with joystick buttons. Rear hydraulic outlets should not be connected at the same time as hydraulic outlet, front. Hydraulic oil flow max 42 l/min.

7007039



LED Work Lighting
Work lighting with efficient LEDs. The lighting package contains seven LED fixture mounted forward, back and on the sides of the top of the roll bar, and a fixture attached to the front end to provide effective lighting for the attachment.

7006037



Hydraulic Quick Lock
Change attachments quickly and easily without leaving the driver's seat.

7005417



Rear View Mirrors
Rear view mirrors mounted on each side of the loader provide a comfortable and secure drive.

7004533



Traffic Equipment
Lights and equipment necessary for driving on public roads. Inspection and registration is required for driving on public roads and can vary between countries. Consult your dealer for advice regarding inspection in your region.

7004520



Beacon Light
Warns surroundings of working vehicle.

7004518



Rear Working Lights
Effective lighting, mounted at the back of the protective cage.

7004517



Mounting Plate for Counter Weight and Hitch
Mounting plate for attaching hitch, along with space for 4 x 45 kg extra weights.

7004525



Hitch Combo
Hitch with standard 50 mm ball combined with pin for trailer towing eye. Mounting Plate 7004525 needed for installation.

7004524



Hitch
Hitch with standard 50 mm ball. Mounting Plate 7004525 needed for installation.

7004523



Counter Weight 45 kg
Increases the machine's stability during handling of heavy loads. Easily installed without tools on Mounting Plate 7004525. Max 4x (180kg).

7004526



Counter Weight Bracket
Handy and compact counterweight for a-series loaders. The counterweight's and accessories' bracket is installed easily with a bolted connection on the chassis.

7008284



Counter Weight 29 kg
Counterweights are selected as needed and locked in place with a through bolt. The counterweights are designed with lifting points and notches in order to facilitate manual handling. Mounting on bracket 7008284. Max (250 kg).

7008285



Counter Weight System
Combination of 7008284 and 7008285. Recommendation for a6226, five to eight pieces.

7004586



Engine Pre-heater
Improves starting ability and decreases wear during cold starts. Recommended plug-in time 30 min.

7004516



Windshield
Protects against flying debris when working, for example, with flail shredder, hydraulic hammer, or snow blower. Windshield wipers and washer included.

7004527



Seat Heater
Heat in the seat's sitting part increases comfort when driving in cold weather.

7004515



Comfort seat
Designed with a low-profile mechanical suspension that significantly reduces vibrations. Weight adjustment range 50-170 kg. Adjustable or foldable armrests, Backrest extension.

7006832



Seat Heater, Comfort seat
Heat in the seat's sitting part and backrest increases comfort when driving in cold weather.

7004515



Bottom Armour
Steel plate mounted below the engine and front frame, protects the machine when working in difficult terrain.

7004519



Generator 60A
A more effective generator for machines with high power consumption. Recommended for machines with traffic equipment and cab with heat.

7004535

