



Norcar a6026

Engine

Make	Kubota
Model	1105
Cylinders	3
Fuel type	Diesel
Cylinder volume cm ³	1123
Cooling system	Fluid

Power

SAE, gross power kW/hp	19,4/26,4
Max gross torque Nm	72
At engine speed r/min	2200
Max engine speed without load r/min	3000

Electrical system

Battery V-Ah	12-53
Generator A	40

Service volumes

Cooling system l	6
Engine oil l	5
Fuel tank l	20
Hydraulic tank l	50
Hydraulic system total volume l	55

Performance

Lifting power hydraulic kg	1150
Breakout force 50 cm kg	960
Tipping load, straight kg	960
Tipping load, articulated kg	770
Operating weight kg	1320
Drive speed km/h	0-11
Pulling force kg	950

Hydraulic system

Working hydraulics l/min	24
System pressure bar	240
Drivetrain hydraulics l/min	63
Drivetrain max system pressure bar	350

Cycle times

Raising boom s	3,7
Lowering boom s	2,2
Folding in bucket s	2,6
Tipping bucket s	1,6
Steering wheel rotations L/R rev	3/4

Tires

Dimension	23x8,5-12IN
-----------------	-------------

Versatile and efficient

Norcar a6026 is essentially a versatile working machine. The stable extension boom allows high-lift tasks to be completed easily and safely. The lifting height with pallet forks is 2.8 meters. The lifting boom is simply and comfortably controlled using a joystick with an electric switch to control extension and auxiliary hydraulics.

An adjustable steering wheel and a comfortable suspension seat provides a restful ride. The drive system with a foot throttle and direction pedal allows the loader to be controlled with incredible precision, even with demanding equipment and terrain. Norcar a6026 is an effective tool where jobs vary between loading trucks, shoveling snow, and moving soil.

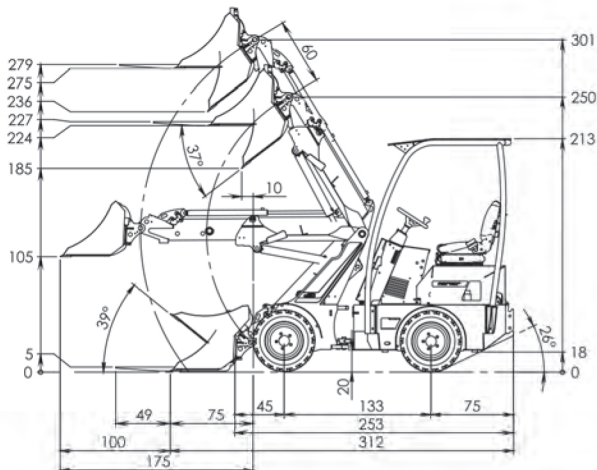
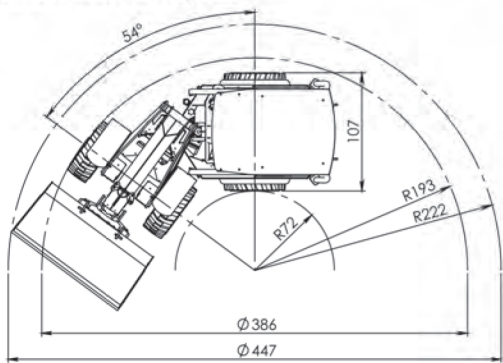

3010 mm

26 hp

0-11 km/h

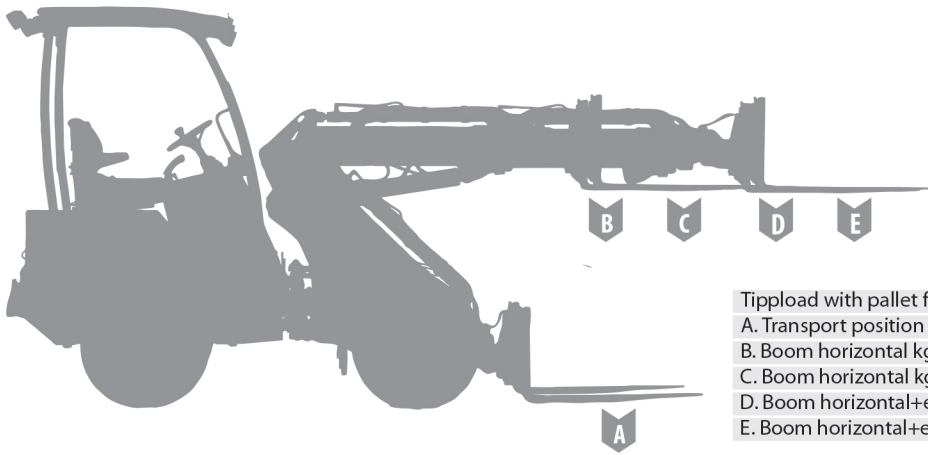

	Standard machine		+extra weight 180 kg	
Tipload with pallet fork	Straight	Articulated	Straight	Articulated
A. Transport position kg	700	700	700	700
B. Boom horizontal kg	1000	730	1000	950
C. Boom horizontal kg	805	510	805	660
D. Boom horizontal+extension kg	690	440	720	570
E. Boom horizontal+extension kg	560	340	560	425

Standard equipment a6026

- Roll bar ROPS/FOPS, seatbelt
- Working lights, front
- Electrically maneuvered parking brake/safety system
- Float on the lifting boom
- Hand throttle/Foot throttle
- Engine speed and hour meter, engine heat and fuel level gauges
- Suspension seat with armrests
- Adjustable steering column
- ProDrive



MultiFaster Quick release coupling

The MultiFaster Quick release makes changes of hydraulic tools easy and quick. All the hydraulic connections are completed with a simple hand motion and makes it impossible to cross connect. Pressure is automatically released and no oil will leak.



Telescope Extension Boom

600mm telescope boom gives good lifting height and reach. Electronically controlled using lifting boom's joystick.



Tire 23 x 8,5-12 IN

Durable multi-purpose tire that can withstand heavy loads. Suitable for work on harder surfaces such as asphalt, concrete, and hard packed gravel. Machine width 107 cm.



FOPS Protective Roof

Steel roof that protects the operator from falling objects.



Traction control

Provides better traction on slippery or uneven surfaces. Traction is guaranteed on the same side wheels.

Extra equipment a6026



Environmental engine

Diesel engine with emission class Tier 4. Environmentally friendly engine with low emissions. The engine is built to meet the emission requirements for Tier 4 in the United States.

7006749



Full traction control

Provides continuous traction on all wheels, regardless of terrain.

7001831



Parallel leveller

Keeps equipment in the set position regardless of the boom's movements. Increases safety and precision during lifts, especially with pallet forks.

7001741



Oscillation lock

Locks the loader's pendular movement in the joint. Can be used during eg.leveling tasks when the tool needs to be parallel to the rear wheels.

7002337



Two Speed Ranges

Change between pulling force and speed. Low gear: 0-9km/h, pulling force 1100kg High gear: 0-19km/h, pulling force 550kg.

7001739



Automotive

Automotive drive system allows the operator to change direction using a control switch on the loaders joystick. The loader is easy to operate and especially suitable for loading, janitorial jobs and when there's a need for driving longer distances.

7007410



Tire 23 x 10 -12 IN

Compact puncture proof tire without air. Durable and can withstand heavy loads. Increases machine weight. Machine width 113 cm.

7001767



Tire 23 x 10,5 -12 TR

Tractor patterned tire. Provides good traction and is suitable for softer surfaces such as soil, sand, and gravel. Tread pattern is designed to keep the tire clean while driving on wet surfaces. Machine width 113 cm.

7001768



Tire 23 x 10,5-12 GR

Densely patterned tire. Soft tire that is gentle to surfaces and grips well. Suitable for work on grass, gravel paths and roads. The tire is also good on snow and ice. Tire width gives low ground pressure. Machine width 113 cm.

7001769



Tire 23 x 12,5 -12 GR

Densely patterned tire. Soft tire that is gentle to surfaces and grips well. Suitable for work on grass, gravel paths and roads. The tire is also good on snow and ice. Tire width gives low ground pressure. Machine width 125 cm

7001746



Tire 23x8,5-12 GR

Densely patterned tire. Soft tire that is gentle to surfaces and grips well. Suitable for work on soft ground like grass, gravel paths and roads. The tire is also good on snow and ice. Machine width 99 cm.

7007036



Tire 23 x 8,5-12 IN

Durable multi-purpose tire that can withstand heavy loads. Suitable for work on harder surfaces such as asphalt, concrete, and hard packed gravel. Machine width 99 cm.

7001744



Hydraulic Outlet, rear, single

Rear hydraulic outlet. Single acting 2 and free return 3. Works in parallel with front outlets and controls hydraulic attachments directly with joystick buttons.

7001742



Hydraulic Outlet, rear, double

Double acting hydraulic outlet (R1 and R2) and free return (R3). Controls hydraulic attachments directly with joystick buttons. Rear hydraulic outlets should not be connected at the same time as hydraulic outlet, front. Hydraulic oil flow max 24 l/min.

7007038



Extra Hydraulic Outlet, front

Electrically operated double-acting hydraulic outlets (4 and 5). Provides the ability to control several hydraulic functions on attachments directly with buttons on the joystick. Hydraulic oil flow max 24 l/min.

7001743



Hydraulic Quick Lock

Change attachments quickly and easily without leaving the driver's seat.

7005416



Hydraulic Oil Cooler

Maintains hydraulic oil's temperature at correct level while operating tools that require high oil flow during long driving periods.

7001835



LED Work Lighting

Work lighting with efficient LEDs. The lighting package contains seven LED fixture mounted forward, back and on the sides of the top of the roll bar, and a fixture attached to the front end to provide effective lighting for the attachment.

7006036



Rear View Mirrors

Rear view mirrors mounted on each side of the loader provide a comfortable and secure drive.

7002604



Traffic Equipment

Lights and equipment necessary for driving on public roads. Inspection and registration is required for driving on public roads and can vary between countries. Consult your dealer for advice regarding inspection in your region.

7001825



Hitch

Hitch with standard 50 mm ball. Mounting Plate 7001923 needed for installation.

7001836



Rear Working Lights

Effective lighting, mounted at the back of the protective cage.

7001749



Hitch Combo

Hitch with standard 50 mm ball combined with pin for trailer towing eye. Mounting Plate 7001923 needed for installation.

7001837



Mounting Plate for Counter Weight and Hitch

Mounting plate for attaching hitch, along with space for 4 x 45 kg extra weights.

7001923



Counter Weight 45 kg

Increases the machine's stability during handling of heavy loads. Easily installed without tools on Mounting Plate 7001923. Max 4x (180kg).

7001911



Counter Weight Bracket

Handy and compact counterweight for a-series loaders. The counterweight's and accessories' bracket is installed easily with a bolted connection on the chassis.

7008284



Counter Weight 29 kg

Counterweights are selected as needed and locked in place with a through bolt. The counterweights are designed with lifting points and notches in order to facilitate manual handling. Mounting on bracket 7008284. Max 8 (250 kg).

7008285



Counter Weight System

Combination of 7008284 and 7008285. Recommendation for a6026, five to eight pieces.

7004586



Windshield
Protects against flying debris when working, for example, with flail shredder, hydraulic hammer, or snow blower.
Windshield wipers and washer included.

7002318



Beacon Light
Warns surroundings of working vehicle.

7001750



Generator 60A
A more effective generator for machines with high power consumption. Recommended for machines with traffic equipment and cab with heat.

7003279



Seat Heater
Heat in the seat's sitting part increases comfort when driving in cold weather.

7001747



Comfort seat
Designed with a low-profile mechanical suspension that significantly reduces vibrations. Weight adjustment range 50-170 kg. Adjustable or foldable armrests, Backrest extension.

7006834



Seat Heater, Comfort seat
Heat in the seat's sitting part and backrest increases comfort when driving in cold weather.

7006835



Bottom Armour
Steel plate mounted below the engine and front frame, protects the machine when working in difficult terrain.

7001751



Engine Pre-heater
Improves starting ability and decreases wear during cold starts. Recommended plug-in time 30 min.

7001748

